

TOTO

Wallhung Bidet B762E

GB

Perform the installation work properly according to this Installation Guide so that the product can function well.





After installation, fully explain how to use to your customer.



Cautions and warnings (Always observe these warnings.)

Before installation, read these "Cautions and warnings" carefully and attach the equipment correctly. This manual uses various indications to guide safe installation of the product and to prevent injury to customers or other people and damage to property. This product should be installed by a professional. The indications and their meanings are as follows.

Symbol example	Meaning of symbol
 CAUTION	This indicates that misoperation could result in injury or physical damage.

The following symbols are used to classify and explain instructions that must be Followed.

	The  symbol indicates something that is prohibited.		The  symbol indicates something that must be done.
---	--	---	---

 CAUTION	
	Always use the included parts or designated parts when installing the equipment.
Required	Follow the Installation Guide thoroughly during installation. Failure to attach things correctly could cause water leaks.
	Do not strike ceramic parts or apply great force to them. Doing so may damage ceramic parts, cause injury, or result in leaks that wet household goods or other items, causing property damage.
Prohibited	

DE

Führen Sie die Installationsarbeiten entsprechend dieses Installationshandbuchs durch, um sicherzustellen, dass das Produkt richtig funktioniert. Geben Sie dem Kunden nach der Installation genaue Anweisungen zur Benutzung.



Vorsichtsmaßnahmen und Warnungen

(Beachten Sie diese Warnungen immer.)

Bitte lesen Sie diese "Vorsichtsmaßnahmen und Warnungen" vor der Installation aufmerksam durch und bringen Sie das Produkt entsprechend an. Diese Anleitung enthält zahlreiche Hinweise zur sicheren Installation des Produkts sowie Anmerkungen, wie Sie Verletzungen und Schäden vermeiden können. Das Produkt sollte durch einen professionellen Installateur eingebaut werden. Die Hinweise und ihre Bedeutung sind im Folgenden erklärt.

Symbol-Beispiel	Bedeutung des Symbols
 VORSICHT	Dies weist darauf hin, dass ein falscher Betrieb zu Verletzungen oder körperlichen Schädigungen führen kann.

Die folgenden Symbole werden verwendet, um Anweisungen zu klassifizieren und zu erläutern, die befolgt werden müssen.

	Das Symbol  gibt an, dass etwas verboten ist.		Das Symbol  gibt etwas an, das getan werden muss.
---	--	---	--

 VORSICHT	
	Verwenden Sie bei der Installation ausschließlich die im Lieferumfang enthaltenen oder für das Gerät bestimmten Teile.
Unbedingt notwendig	Befolgen Sie bei der Installation die Anweisungen in der Installationsanleitung genau. Bei fehlerhaften Verbindungen kann Wasser austreten.
	Lassen Sie keine Gegenstände auf die Keramikteile fallen und üben Sie keine übermäßige Kraft auf sie aus. Hierdurch können Keramikteile beschädigt werden und es kann zu Verletzungen oder undichten Stellen kommen, wodurch Haushaltsgegenstände o.ä. in Kontakt mit Wasser geraten oder Wasserschäden anderer Art entstehen können.
Verboten	

FR

Exécutez correctement l'installation en suivant ce Guide d'installation afin que le produit fonctionne convenablement. Une fois l'installation terminée, expliquez bien au client comment il doit utiliser le produit.





Mises en garde et avertissements

(Respectez toujours ces avertissements.)

Avant l'installation, lisez attentivement ces "Mises en garde et avertissements" et fixez convenablement l'appareil. Ce manuel utilise diverses indications pour faciliter l'installation sûre du produit et éviter toute blessure aux clients ou à d'autres personnes et tous dommages à vos biens. Ce produit devrait être installé par un expert. Les indications et leurs significations sont les suivantes.

Exemple de symbole	Signification du symbole
 MISE EN GARDE	Cela indique que toute utilisation incorrecte pourrait entraîner une blessure ou un dommage physique.

Les symboles suivants sont utilisés pour classifier et expliquer les instructions devant être suivies.

	Le symbole  indique que quelque chose est interdit.		Le symbole  indique que quelque chose doit être fait.
---	--	---	--

 MISE EN GARDE	
	Utilisez toujours les pièces fournies ou les pièces recommandées lorsque vous installez l'appareil.
Requis	Suivez le guide d'installation avec attention pendant l'installation. Un branchement incorrect pourrait entraîner des fuites d'eau.
	Ne frappez pas sur les pièces en céramique et ne les soumettez pas à une force importante. Cela pourrait endommager les pièces en céramique, entraîner des blessures ou provoquer des fuites pouvant mouiller vos objets domestiques ou autres et endommager vos biens.
Interdit	

IT

Eseguire l'installazione in modo appropriato, attenendosi alle istruzioni riportate nel presente Manuale di installazione, in modo che il prodotto possa funzionare correttamente. In seguito all'installazione, spiegare al cliente come utilizzare il prodotto.





Avvisi di Pericolo e Attenzione

(Si raccomanda di attenersi scrupolosamente a quanto indicato in questi avvisi.)

Prima di procedere all'installazione, leggere attentamente i presenti "Avvisi di Pericolo e Attenzione" e collegare l'apparecchio in modo corretto. Questo manuale contiene varie indicazioni importanti per un'installazione corretta e sicura del prodotto, e per evitare infortuni agli utenti e ad altre persone e danni alle cose o agli edifici. Questo prodotto deve essere installato da una persona autorizzata. Gli avvisi, segnalati da apposite icone, hanno il seguente significato.

Esempio di simbolo	Significato del simbolo
 ATTENZIONE	Questo simbolo indica che in caso di operazioni scorrette si potrebbero verificare infortuni o danni fisici.

In questo manuale vengono utilizzati i simboli riportati di seguito per classificare le tipologie di istruzioni contenute nei paragrafi successivi.

	Il simbolo  indica operazioni vietate.		Il simbolo  indica operazioni che devono essere eseguite obbligatoriamente.
---	---	---	--

 ATTENZIONE	
	Durante l'installazione del prodotto, utilizzare sempre i componenti forniti in dotazione o specificate.
Obbligatorio	Durante l'installazione, attenersi scrupolosamente al Manuale di installazione. Se i collegamenti idraulici non vengono eseguiti correttamente, si potrebbero verificare fuoriuscite d'acqua.
	Fare attenzione a non urtare le parti in ceramica e a non esercitare forze eccessive su di esse. In caso contrario, le parti in ceramica potrebbero venire danneggiate e si potrebbero provocare infortuni o fuoriuscite d'acqua, con il rischio di bagnare gli oggetti della casa o altri oggetti e di provocare danni all'edificio.
Divieto	

Included Parts
Im Lieferumfang enthaltene Teile
Pièces fournies
Parti in dotazione

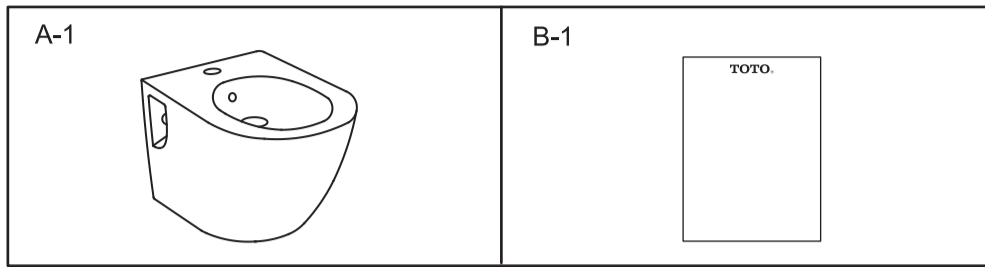

Before Installing the bidet
Vor der Installation des Bidets
Avant d'installer le
Prima di installare i

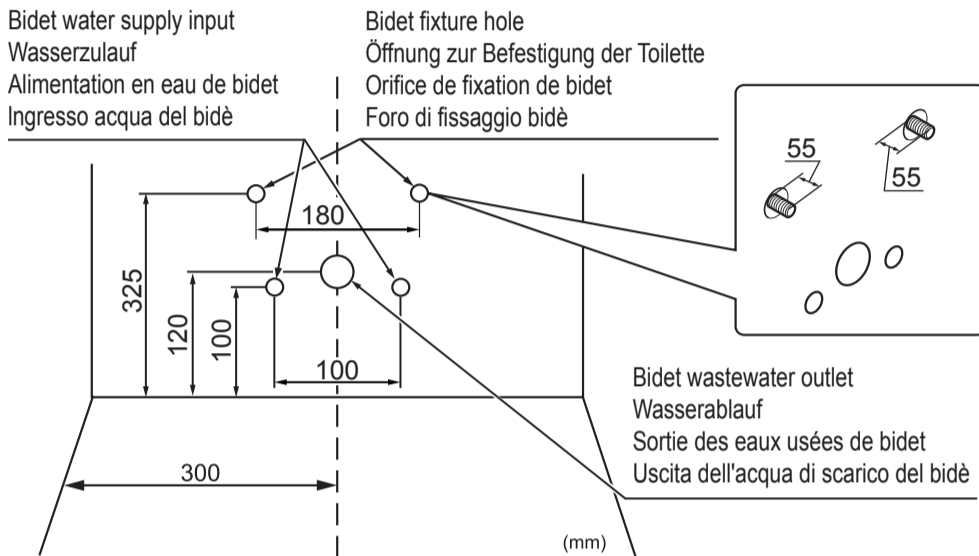

Installation Procedures
Vorgehensweise für die Installation
Procédures d'installation
Procedura di installazione

1

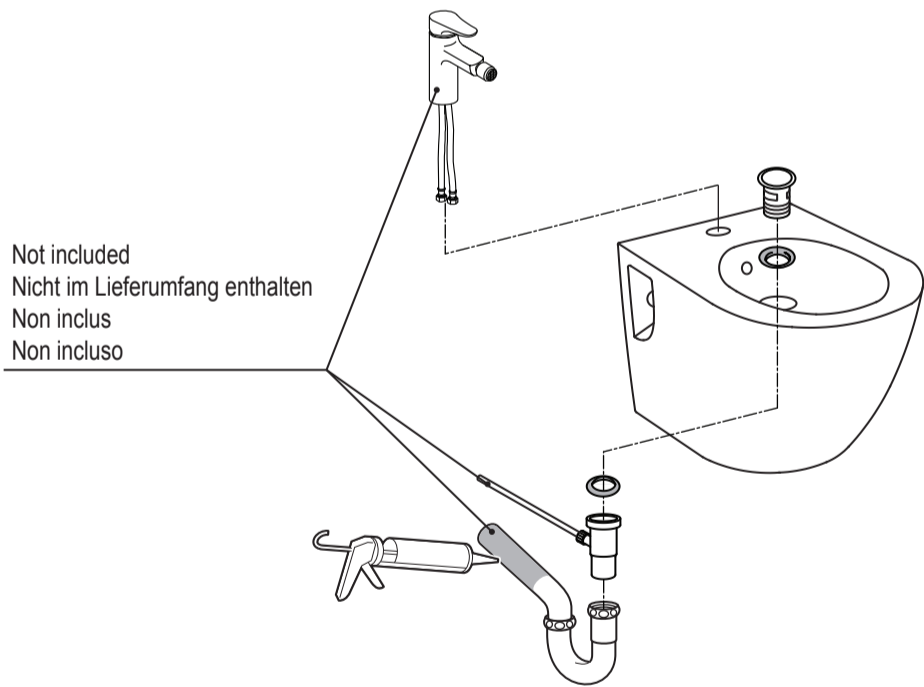

2

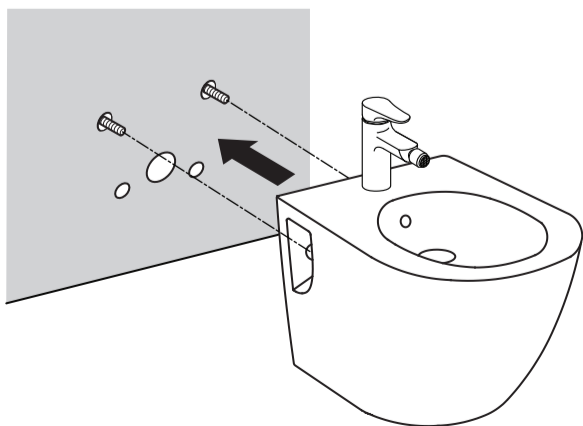

3

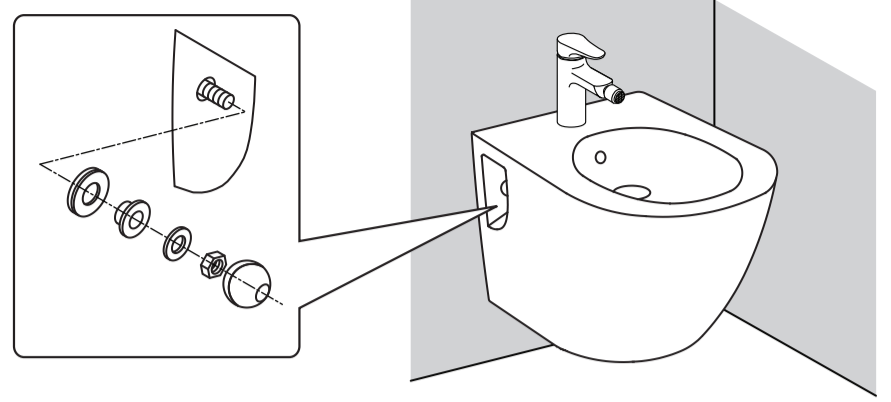

4

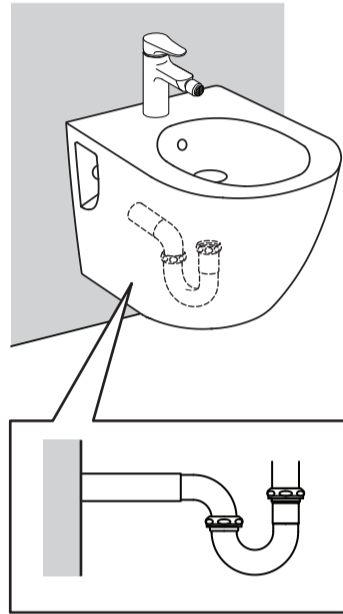

[GB]	CAUTION
Required	Connect the P-trap to the wastewater outlet. (not included) Incomplete connection could cause water to leak.
[DE]	VORSICHT
Erforderlich	Den P-Anschluss mit dem Wasserablauf verbinden. (nicht im Lieferumfang enthalten) Ist er nicht richtig verbunden, kann es zu undichten Stellen führen.
[FR]	MISE EN GARDE
Requis	Connectez le P-trap à la sortie des eaux usées. (non inclus) Connexion incomplète pourrait provoquer une fuite d'eau.
[IT]	ATTENZIONE
Obbligatorio	Collegare il P-trappola alla presa delle acque reflue. (non incluso) Collegamento incompleto può causare perdite d'acqua.

5



[GB]	CAUTION
Required	Confirm that the bidet is fastened to the wall securely. Failure to secure the bidet could result in it falling and being damaged.
[DE]	VORSICHT
Erforderlich	Stellen Sie sicher, dass das Bidet sicher an der Wand befestigt ist. Bei unsachgemäßer Befestigung kann es zu Beschädigungen an dem Bidet führen.
[FR]	MISE EN GARDE
Requis	Assurez-vous que le bidet soient fixées convenablement au mur. Une mauvaise fixation pourrait causer la chute de bidet et l'endommager.
[IT]	ATTENZIONE
Obbligatorio	Confermare che il bidè è fissato saldamente alla parete. Se il bidè non è assicurato correttamente, possa cadere e possa venire danneggiato.

6

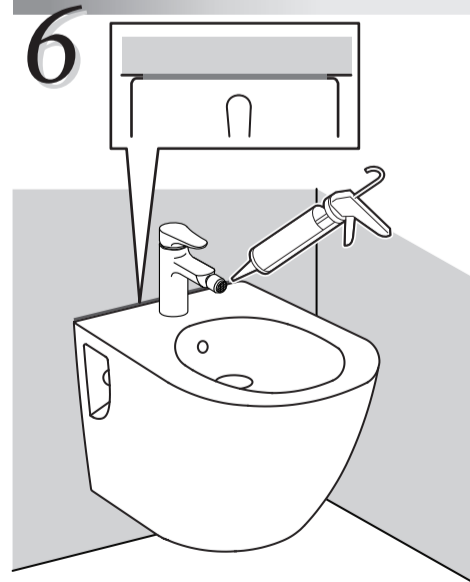

7

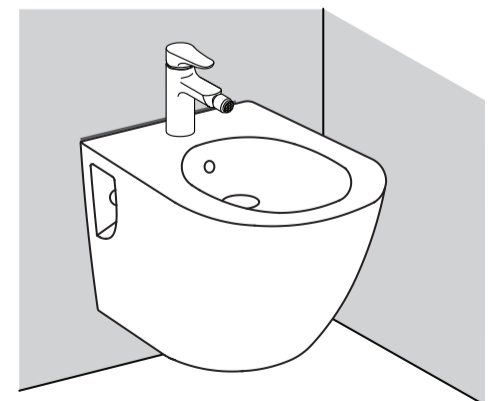

After installation, leave the L-Wrench with the customer.
 Nach Installation, der L-Schlüssel beim Kunden zurücklassen.
 Après l'installation, laisser la clé en forme de L chez le client.
 Dopo l'installazione, lasciare la chiave in forma di L con il cliente.